



# C3X

*Grand Cinema™*



Cod. 46.0533.000

User and Installation Manual  
C3X - C3X LITE



# 1 REMOTE CONTROL AND KEYPAD

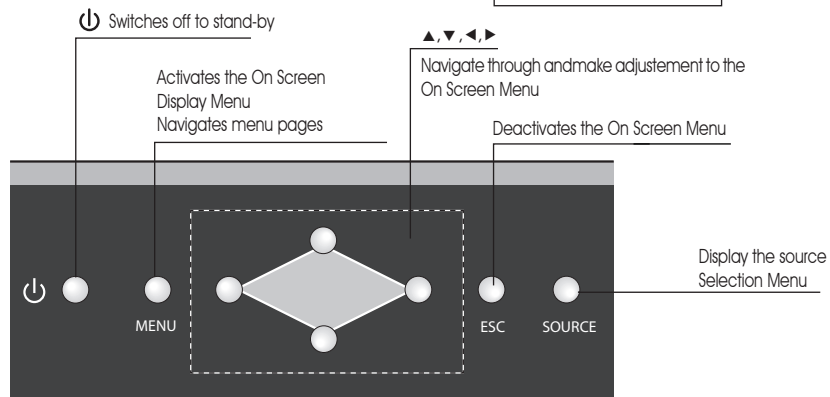
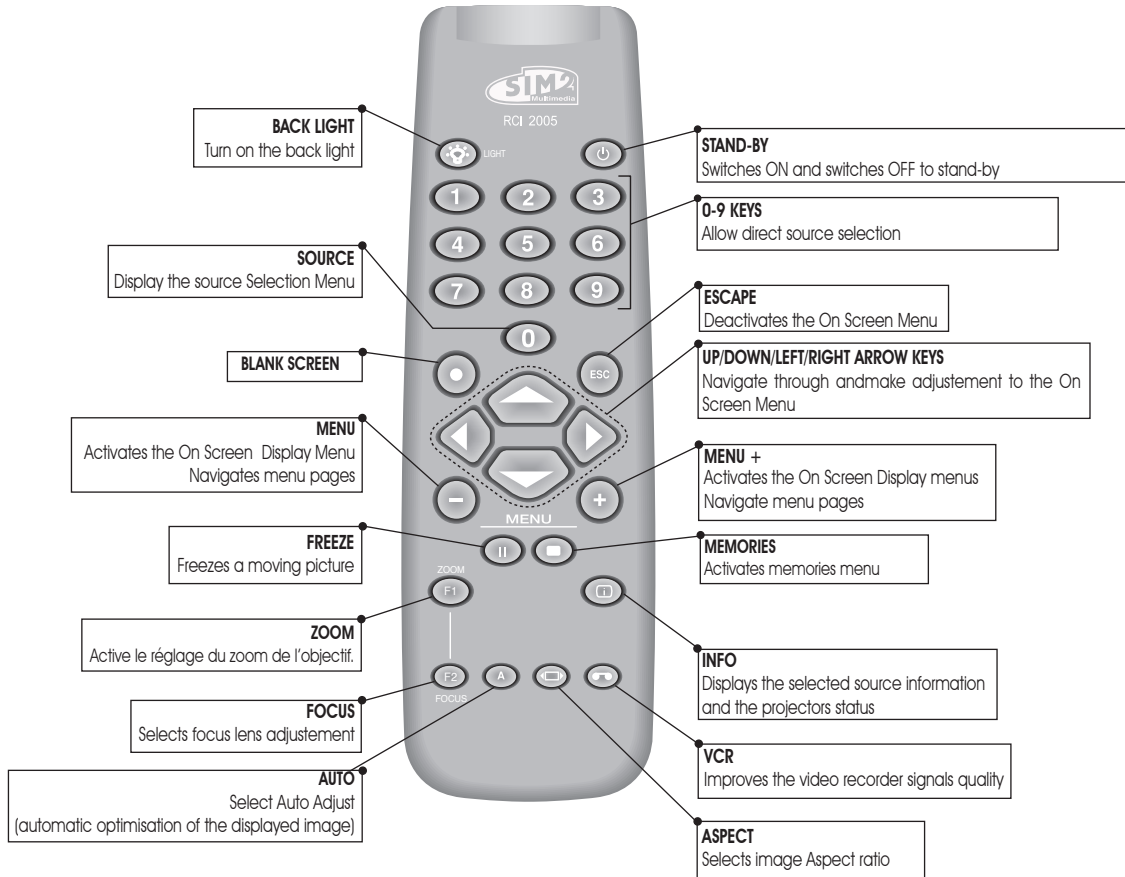

# 1 INTRODUCTION

Thanks to the new optical system based on three chip DMD™, the C3X allows to take advantage from DLP™ technology, the Texas Instruments technology.

Each of the three DMD™ chip is dedicated to the modulation of one of the primary colors coming from the optical prism, the reflected light, after combination by a second prism, is projected outside using an appropriate lens system.

The technology of the C3X allows to obtain images without rainbow effect or any other type of artefact, in order to enjoy an even more realistic images.

The large number of inputs available (1 Composite Video inputs, 1 S-Video inputs, 2 Component or RGB inputs, 1 graphic RGB inputs, 1 HDMI™ Input) ensures the system supports a wide variety of analogue and digital sources: DVD players, VCRs, satellite and terrestrial receivers, computers, game consoles, video cameras, etc.

Conversion of interlaced video signals to progressive signals by means of prestigious DCDi™ technology produces fluid, natural, images free of flicker and stairstepping artefacts.

Faithful reproduction of signals at higher resolutions (such as high definition video and graphics) occurs without loss of information or reduction of image sharpness thanks to the processor's high pixel rate signal acquisition capabilities.

Adaptation of the input signal resolution to the Projector resolution occurs without alterations of image quality, in accordance with an ample choice of aspect ratios, including several definable by the user.

All image adjustments can be performed with the remote control with the aid of the On Screen Display; alternatively, the unit can be controlled by from a home automation system through the serial port.

**SIM2 carries out comprehensive functional testing in order to guarantee the maximum product quality.**

**For this reason, when you start using the product lamp operating hours may already be at between 30 and 60.**

**In addition to the regular tests, the Quality Control department performs additional statistical tests at the time of shipment.**

**In this case the packing may show signs of having been opened, and the accumulated lamp operating hours may be slightly higher than the hours associated with the standard tests.**

## TABLE OF CONTENTS

1	PRESENTATION	3	10	CLEANING AND MAINTENANCE	26
2	IMPORTANT SAFETY INSTRUCTION	4	11	TROUBLESHOOTING GUIDE	26
3	DISIMBALLO	7	12	OPTIONAL ACCESSORIES	27
4	UNPACKING	8		A - Technical specifications	28
5	SWITCHING ON AND OFF THE PROJECTOR	10		B - On Screen Menu	29
6	CONNECTION	10		B - Dimensions	30
7	CONNECTION PANEL	12			
8	REMOTE CONTROL	14			
9	ON SCREEN MENU	15			



DLP and DMD are registered trademarks of Texas Instruments.  
HDMI, the HDMI logo and High-Definition Multimedia Interface are trademarks or registered trademarks of HDMI Licensing LLC

## 2 IMPORTANT SAFETY INSTRUCTIONS



This symbol indicates the presence of important instructions regarding use and maintenance of the product.



This symbol indicates the possible electric shock hazard associated with uninsulated live components in the interior of the unit.

### ATTENTION:

To reduce the risk of electric shock, disconnect the power supply cable on the rear panel before removing the top cover of the projector. Refer to trained, authorised personnel for technical assistance.

### LAMP WARNING:

If the lamp should suddenly break with a loud bang, air the room thoroughly before using it. Do not replace the lamp: seek qualified technical assistance from your nearest Dealer.

### ENVIRONMENTAL INFORMATION:

The product you have purchased contains extracted natural resources that have been used in the manufacturing process. This product may contain substances known to be hazardous to the environment or to human health. To prevent releases of harmful substances into the environment and to maximize the use of natural resources, SIM2 Multimedia provides the following information on how you can responsibly recycle or reuse most of the materials in your "end of life" product. Waste Electrical and Electronic Equipment (commonly known as WEE) should never be disposed of in the municipal waste stream (residential garbage collection). The "Crossed-Out-Waste Bin" label affixed to this product is in your reminder to dispose of your "End of Life" product properly. Substances such as glass, plastic, and certain chemical compounds are highly recoverable, recyclable, and reusable. You can do your part for the environment by following these simple steps:

1. When your electrical or electronic equipment is no longer useful to you, "take it back" to your local or regional waste collection administration for recycling.
2. In some cases, your "end of life" product may be "traded in" for credit towards the purchase of new SIM2 Multimedia equipment. Call SIM2 Multimedia to see if this program is available in your area.
3. If you need further assistance in recycling. Reusing, or trading in your "end of life" product, you may contact us at the Customer Care number listed in your products user guide and we will be glad to help you with our effort.

Finally, we suggest that you practice other environmentally friendly actions by understanding and using the energy-saving features of this products (where applicable), recycling the inner and outer packaging (including shipping containers) this product was delivered in, and by disposing of a or recycling used properly.

With your help, we can reduce the amount of natural resources needed to produce electrical and electronic equipment, minimize the use of landfills for the disposal of "end of life" products, and generally improve our quality of life by ensuring that potentially hazardous substances are not released into the environment and are disposed of properly.

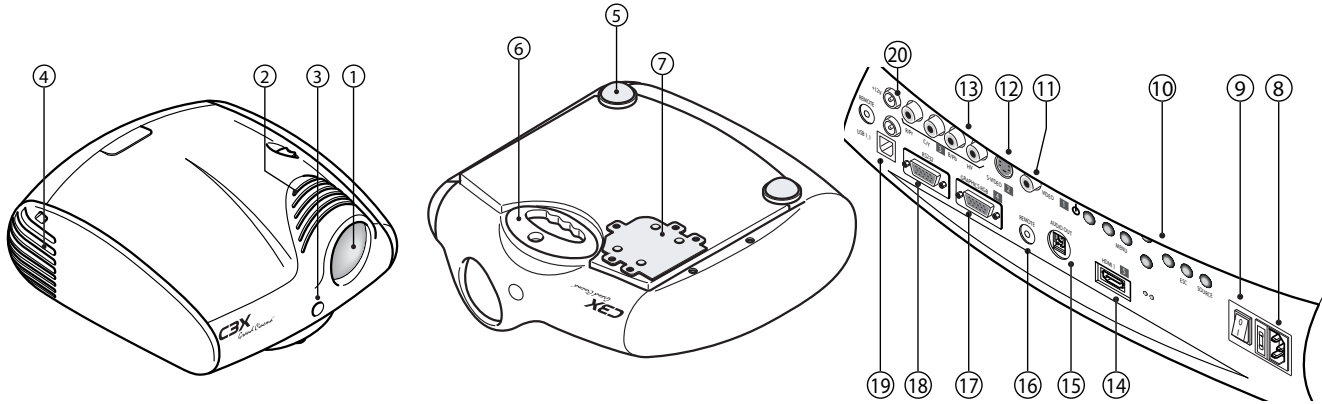

Prior to switching on the projector please read each chapter of this manual carefully as this manual provides basic instructions for using the projector. The installation of the lamp assembly, preliminary adjustments and procedures that necessitate the removal of the top cover, must be carried out by authorised, trained technicians. There are no user serviceable parts inside. To ensure safe and long term reliability please use power cables supplied with the projector. Observe all warnings and cautions.

**PROJECTOR**

- 1 Projection lens.
- 2 Aesthetic embasures
- 3 Remote control front / IR sensor
- 4 Cooling air inlet vents
- 5 Adjustable levelling feet
- 6 Adjustable carry-handle
- 7 Lamp Box
- 8 Fused power socket
- 9 Main power switch
- 10 Main function keys

- 11 Composite video input
- 12 S-Video input
- 13 RGB / YPrPb input
- 14 HDMI™ input
- 15 Audio Output
- 16 Remote Control connector
- 17 VGA input
- 18 Serial interfaces RS232
- 19 Interfaces USB 1.1
- 20 12Vdc screen output

- **Read this manual carefully and keep it in a safe place for future consultation.**

This manual contains important information on how to install and use this equipment correctly. Before using the equipment, read the safety prescriptions and instructions carefully. Keep the manual for future consultation.

- **Do not touch internal parts of the unit.**

The unit contain electrical parts carrying high voltages and operating at high temperatures. Do not remove the cover from the unit, refer to qualified service personnel for all repair and maintenance requirements. The warranty will be automatically invalidated if the cover is removed from the unit.

- **Power supply disconnect device.**

The device for disconnecting the units from the mains power supply is constituted by the power cable plug. Ensure that the power cable plugs and the electrical mains socket outlets are easily accessible during installation operations. To disconnect the unit from the electric power supply, pull the plug to remove it from the socket outlet. Do not pull the power cable.

- **Use only the specified type of mains power supply.**

Connect the units to a mains electrical supply with rated voltage of between 100-240 VAC, 50/60 Hz and equipped with a protective earth connection. If you are unsure of the type of mains power supply in your home, consult a qualified electrician. Ensure that the power draw of the units is commensurate with the rating of the electrical socket outlets and any extension cables that are used.

- **Connect the unit to a mains electrical supply**

Make the connection as shown in Fig.2

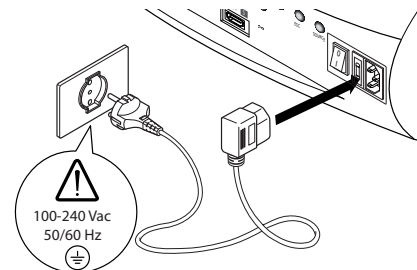

Fig.2

**Replace the safety fuse**

**Before making the replacement disconnect the appliance from the mains power supply.**

The fuse compartment is close to the mains power connector (Fig. 3). Use a slotted screwdriver to remove the fuse carrier (2) and replace the fuse (3). Insert a new spare fuse (4). Use only T 5A H fuses.

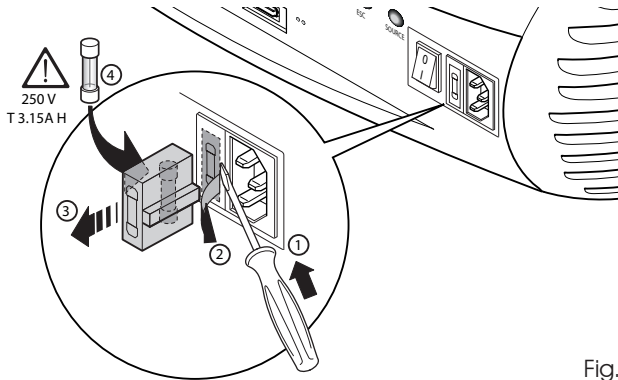

Fig.3

- **Beware of power supply cables.**

Position the power supply cables so that they do not constitute an obstruction. Position the power supply cables where they cannot be reached by children. Install the units as close as possible to the wall electrical socket outlet. Do not tread on the power cables, make sure that they are not tangled or pulled; do not expose the power cables to heat sources; make sure that the power cables do not become knotted or kinked. If the power cables become damaged, stop using the system and request the assistance of an authorised technician.

- **Disconnect the apparatus from the mains power supply in the event of electrical storms and when not in use.**

To avoid damage that could be caused by lightning striking in the vicinity of your home, disconnect the unit in the event of electrical storms or when the system will remain unused for prolonged periods.

- **Avoid contact with liquids and exposure to humidity.**

Do not use the unit near water (sinks, tanks, etc.); do not place objects containing liquids on top of or near the unit and do not expose them to rain, humidity, dripping water or spray; do not use water or liquid detergents to clean the unit.

- **Prevent the unit from overheating.**

In order to allow the Projector cooling, keep at least 40 cm (16") of space between the rear of the projector and the nearest wall or obstruction. Do not place the devices near heat sources such as heaters, radiators or other devices that generate heat (including amplifiers). Do not obstruct ventilation openings. Do not place the unit in confined, poorly ventilated positions (bookcases, shelves, etc.).

- **Do not expose the eyes to the intense light emitted by the lamp.**

Never look directly at the lamp through the ventilation opening when the unit is switched on. Risk of eyesight impairment. Ensure also that children do not look directly at the lamp.

- **Beware of the lens movements**

Avoid positioning objects close the lens. The movements (horizontal and vertical) could be obstructed by objects, or damage may arise from the fall of the objects.

- **Position the unit on a stable surface.**

To avoid serious injury to persons and damage to property, make sure the units are placed on a level, flat and stable surface from which they cannot fall, tip over or slide. Pay special attention if the units are placed on a trolley so that they can be moved around. Ensure that the units are not subjected to impact.

- **Do not insert objects through the unit openings.**

Make sure that no objects are inserted inside the units. If this should occur, disconnect the unit from the power supply immediately and call an authorised technician.

- **Energy Saving**

When the system is left idle for a long period disconnect the Projector from the main power supply. This precaution allows to save energy and to prevent wear and tear of the electronics devices.

### 3 UNPACKING

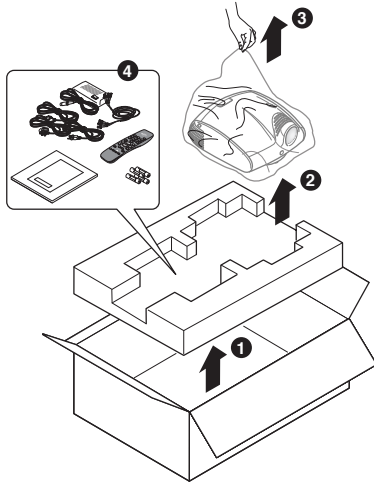

Fig.4

To unpack the projector safely and easily please follow steps 1 to 5, as per drawing (Fig. 4).

It is recommended that the carton and packaging is retained for future use and in the unlikely event that your projector needs to be returned for repair.

### PACKAGE CONTENTS

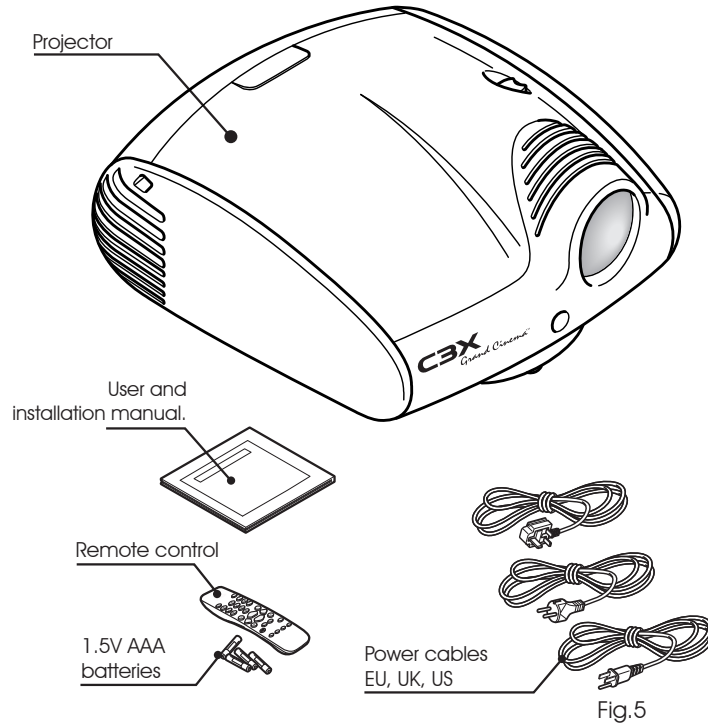

Fig.5

The carton should contain the following:

- the projector
- the remote control
- four 1.5V AAA batteries (for remote control)
- three power cables for the projector (EU, UK, USA)
- the user and installation manual.

If any accessories are missing, contact your Dealer as soon as possible (Fig. 5).



## 4 INSTALLATION

**CAUTION:** In the case of ceiling or wall mounting using a suspension bracket, follow the instructions carefully and comply with the safety standards you will find in the box together with the bracket. If you use a bracket different to the one supplied by SIM2 Multimedia, you must make sure that the projector is at least 65 mm (2-9/16 inch) from the ceiling and that the bracket is not obstructing the air vents on the lid and on the bottom of the projector.

Adjust the feet underneath to obtain a level position, lining up the base of the projected image to the base of the projection screen (Fig. 6).

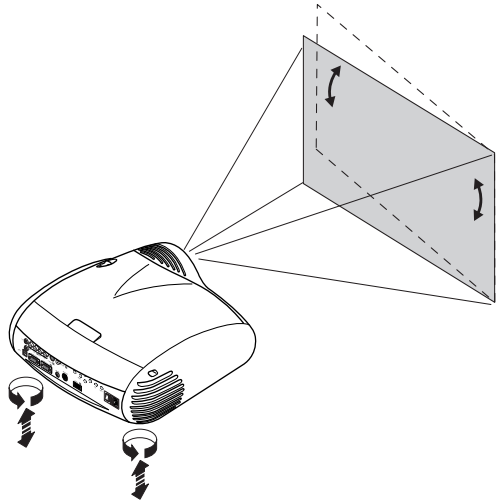

Fig. 6

Position the projector the desired distance from the screen: the size of the projected image is determined by the distance from the lens of the projector to the screen and the zoom setting. See "Appendix C": Projection distances" for more information.

Use the motorised lens zoom to adjust the image size and the motorised lens focus to achieve maximum clarity. With optimum focus you should be able to clearly see each single pixel when within close proximity to the screen (Fig. 7).

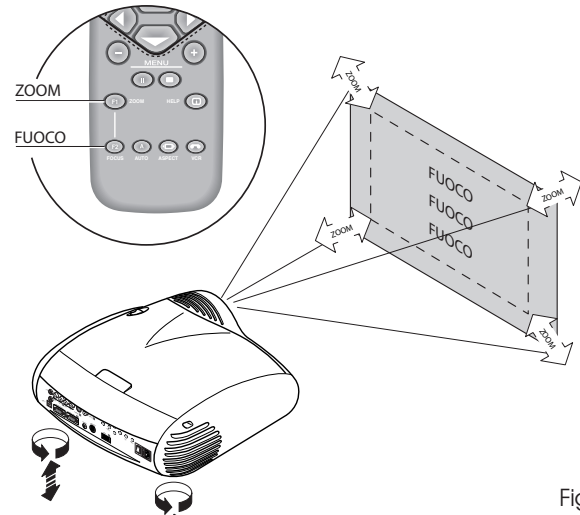

Fig. 7

In the event you are unable to centre the image within the screen area, tilt the projector until the image is correctly positioned. Any keystone error can be removed by the Keystone adjustment in the Set up menu (Fig. 8-8a).

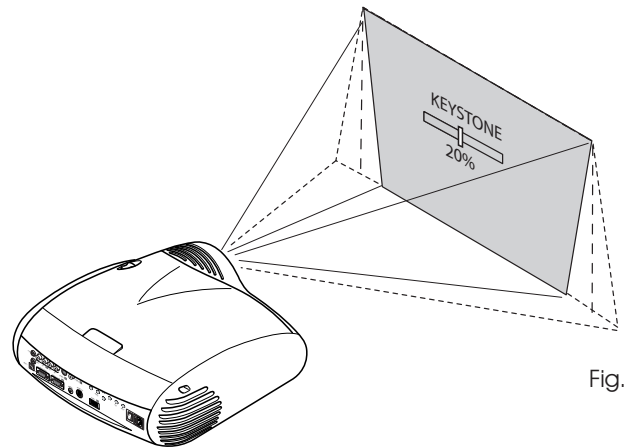

Fig. 8a

The Orientation adjustment in the Set up menu will allow the projector to be used for desktop front, ceiling front, desktop rear and ceiling rear installations (Fig. 9).



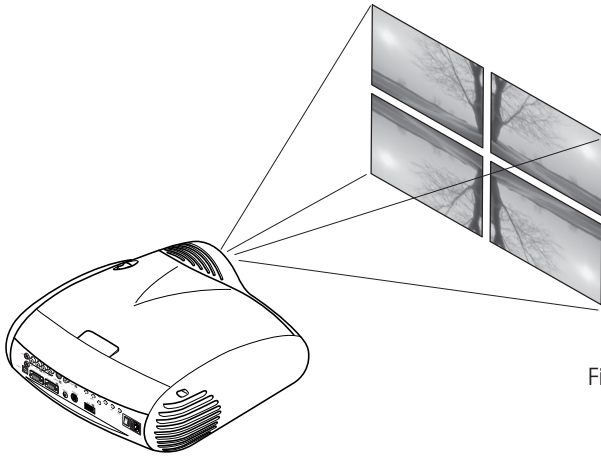



Fig. 9

To activate an electric motorised screen a 12 Volt output is provided at the rear of the projector. This can be connected to a screen interface unit, which can be supplied by screen manufacturers (Fig. 10).

The output is activated (Voltage: 12 Vdc) when the projector is switched on and is de-activated (no Voltage output) when the projector is in stand-by mode.

Some manufacturers offer screen-masking systems to help frame the projected image and improve picture contrast. These systems can be connected to output , at the rear of the projector (Fig. 11).

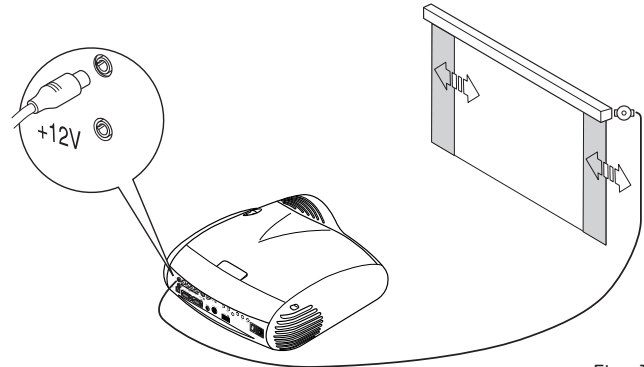

Fig. 11

The use of high gain screens should be avoided due to their limited viewing angle, which is undesirable for a large audience. Preferably, use a screen with black, non-reflecting borders, which will perfectly frame the projected image.

Avoid light shining directly on the screen during projection as this will reduce contrast and black level detail on the projected image. For the true cinema experience best results are achieved with little or no ambient light.

Furniture and other objects with reflecting surfaces, as well as light coloured walls should be avoided, as they are likely to interfere with the screen's characteristics.

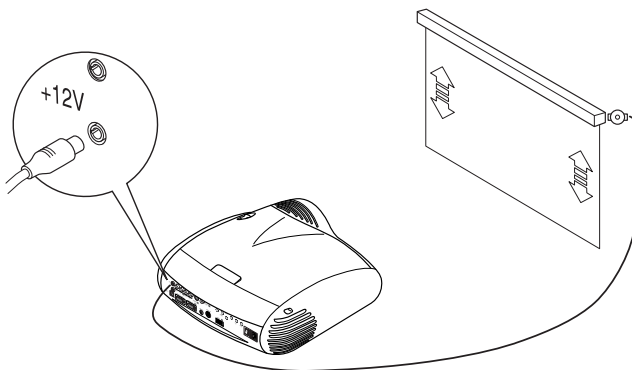

Fig. 10

For rear projection the screen must be translucent. For front projection, we recommend the use of screens with low gain specifications

## 5 SWITCHING ON AND OFF THE PROJECTOR

**CAUTION:** Connect the projector to a power supply with a nominal voltage within the following values: 100-240 Vac, 50/60 Hz. It must be earthed (Fig. 12).

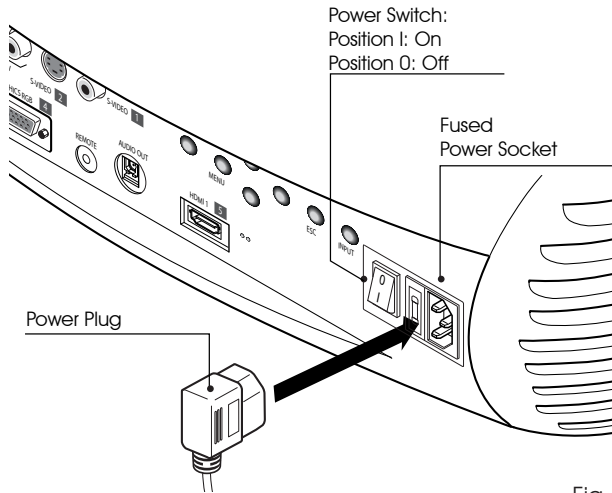

Fig. 12

Upon switch on (in position I) the projector will initialise (red and green LEDs on). Followed by stand-by mode (red LED on) (Fig. 13).

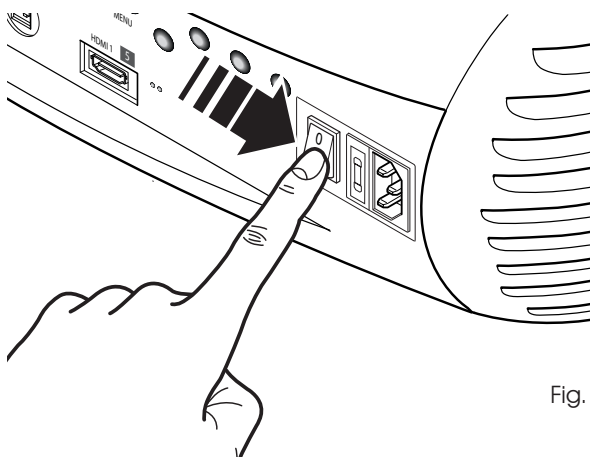



Fig. 13

### SWITCH ON FROM STAND-BY

By remote control: press   
By keyboard: press 

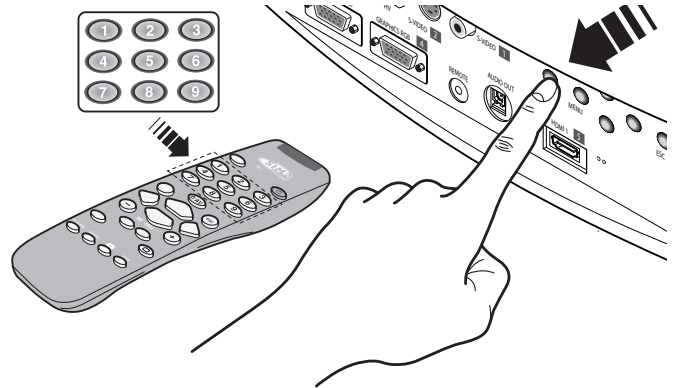

Fig. 14

When switching on from stand-by, the projector will turn on the lamp; after a brief warm up period the image will be displayed (green LED on). The input automatically selected will be the last one memorised prior to switch off (Fig. 14).

You may experience difficulties switching on the projector shortly after switching off: the lamp may fail to come on as it is too hot.













**SWITCHING OFF AND RETURNING TO STAND-BY**

By remote control: press .

By keyboard: press key .

When switching off, the projector goes in to stand-by memorising the input selection at the time of switch-off.

The fans will continue to work until the lamp has cooled down (red and green LEDs flashing) and will stop automatically after this period.

Status	Led blue	Led red	Logo Backlit
Initialisation			Blue Color
Standby			Red Color
On			Off / Blue Color (*)
Cooling			Blue Color
Overtemperature			Red Color
Fan Error			Red Color

 : Off

 : On

 : Flashing

(\*): selectable from OSD

**6 CONNECTIONS**

To obtain the best performance from your projector, we recommend the use of good quality "video cables" to the various signal sources (75 ohm Impedance).

Poor quality cables will cause inferior picture performance.

For optimum connectivity we recommend you follow these simple steps:

- With exception of coaxial RCA/Phono type connectors, always double-check that the plug is inserted the correct way round to avoid damaging the plugs or the sockets on the projector (Fig. 15)
- Remove cables by the plug and do not pull on the cable itself.
- Avoid tangled cables.

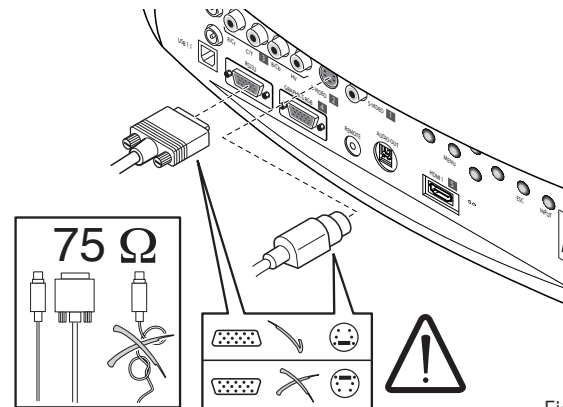
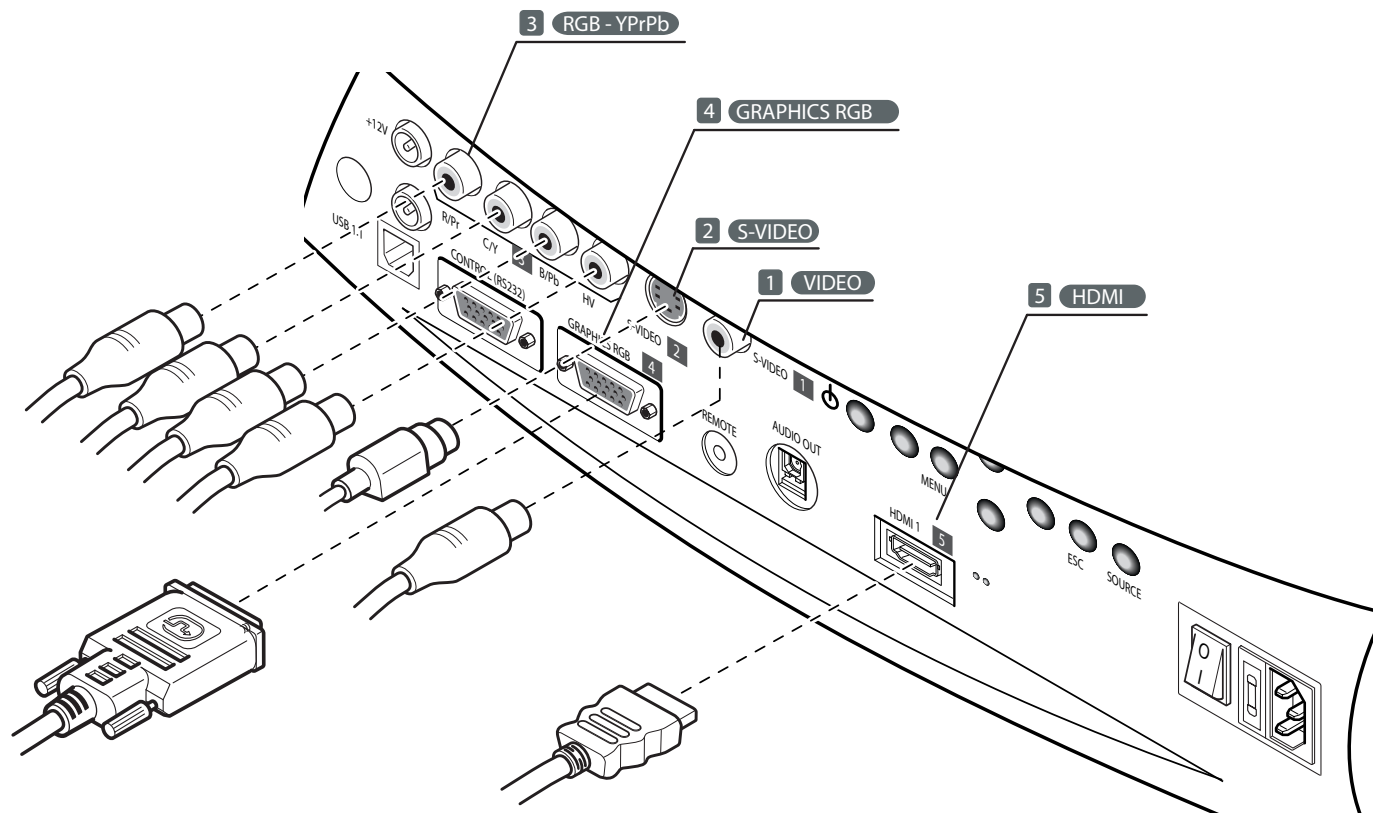

Fig. 15

- Position the cables carefully to avoid a trip hazard - especially in low light areas.

## C3X - CONNECTION



**1 2**

Television receiver  
DVD Player  
Videorecorder  
Camcorder  
Game console

**3**

Television receiver  
HDTV receiver  
Videorecorder  
Camcorder  
Game console

**4**

Computer  
DVD Player

**5**

DVD Player  
HDTV receiver

Fig. 16

---

**COMPOSITE VIDEO 1**

---

This input should be connected to a Composite Video signal (CVBS) by means of a cable with an RCA connector.

The connector on the source is usually yellow and is frequently labelled VIDEO.

Although other types of signals are preferable (since they allow better picture quality), Composite Video signal is still very common, and nearly all television receivers, video-recorders, DVD players, camcorders, etc., are equipped with it.

---

**S-VIDEO 2**

---

This input should be connected to an S-Video signal by means of a cable with a 4-pin mini-DIN type connector.

The corresponding output on the source can be identified by the labels S-VIDEO or Y/C.

Almost as widespread as Composite Video, S-VIDEO is preferable because it offers a clearer and sharper picture.

---

**RGB / YPrPb 3**

---

These inputs are composed of one set of 4 RCA connectors. Each set of connectors is suitable for RGB and Component signals.

RGB signals can have the following sync signals: composite sync on the green signal (RGsB), H+V Composite Sync.

Connect the R, G, B outputs of the source to the respective R, G, B inputs of the C3X (paying attention not to invert the positions) and synch signals to the HV input.

When connecting the three sets of RCA connectors use the colours as a guide: connector R is red, G is green, B is blue, HV is white.

By using a suitable SCART to RCA (or BNC) connector adapter cable, an RGB video signal from a source equipped with an SCART connector can be connected to this input.

- Component signals should be connected to inputs Y, Cr and Cb, taking care to observe the correspondence with the outputs on the source. The connector colours can also be of help, as shown in the table.

The video signals that can be connected to this input can have horizontal scanning frequencies of 15 kHz (standard video resolution), 32 kHz, or higher (progressive scanning video, high

definition video).

Progressive signals usually provide better quality than interlaced signals, but if the source features both progressive and deinterlaced signal outputs it is good practice to compare the quality of the pictures reproduced by the C3X in the two cases: deinterlacing performed by the C3X (thanks to Faroudja DCDi™ technology) is often more effective than that performed at the source.

---

**GRAPHICS RGB 4**

---

This input should be connected to an RGB-type video or graphic signal using a cable with a DB15HD type connector.

The signal source device (typically a personal computer or game console) must be able to provide separate H/V synchronisation or composite H+V.

The video or graphic signals that can be connected to this input can have horizontal scan frequencies (H-sync) of between 32 and 80 kHz and a vertical frequency (V-sync) of between 48 and 100 Hz. Image resolution can vary between 640x480 and 1600x1200 pixels (VGA, SVGA, XGA, SXGA, UXGA).

---

**HDMI™ 5**

---

The HDMI™ (High Definition Multimedia Interface) integrates an uncompressed high definition video signal with a multichannel audio signal and allows the exchange of control data between the video source and the C3X.

The HDMI™ input provides connection to video sources that use the HDCP (High-Bandwidth Digital Content Protection) protocol to protect contents.

Once the video source has been connected to the HDMI™ input, internal processing by the C3X separates the video information from the audio information. Audio information is then made available via an optical digital output with a female Toslink connector in accordance with the S/PDIF standard.



**MOTORISED PROJECTION SCREEN OUTPUT**

Fig. 17

The projector is equipped with two outputs (Voltage: 12 Vdc) for motorised projection screen and screen masking systems. These 12V outputs should be connected to the appropriate screen interface provided by the screen manufacturer (Fig. 17).

The +12V output is activated when the projector is switched on (green LED on) and is de-activated when the projector is in stand-by mode (red LED on).

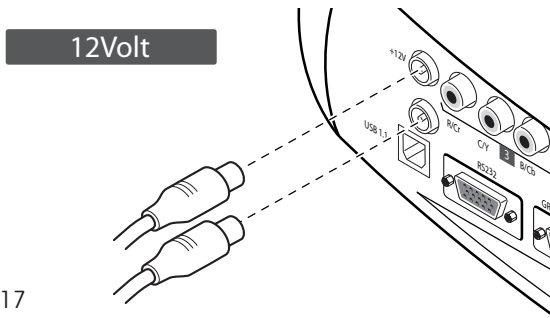
The output  can be used to control a screen masking system; its output can be set with the Screen control adjustment in the Aspect menu. This output allows reduction in the area of a 16:9 screen, into a 4:3 format, by activating a screen masking system (refer to screen manufacturer for further information).

**8 REMOTE CONTROL**

Insert the batteries, taking care to match the polarity, as indicated in the battery recess of the remote (Fig. 23).

Change the batteries in the remote control if experiencing difficulty in sending commands to the projector.

If the remote control is not to be used for a long period of time remove the batteries. Replace all batteries at the same time; do not replace one new battery with a used battery. If the batteries have leaked, carefully wipe the case clean and replace with new batteries.

The remote control sends commands to the projector via infrared signals.

It is possible to control the projector by pointing the remote control at the screen; the sensor at the front of the projector will pick up the reflected infrared commands. (Fig. 19).

**RS232 INTERFACE CONNECTOR**

Fig. 18

It is possible to control the projector through a personal computer. First, load the appropriate projector control software onto your PC.

Avoid placing obstructions between the remote control and the infrared sensor at the front of the projector; this will impair the remote control performance.

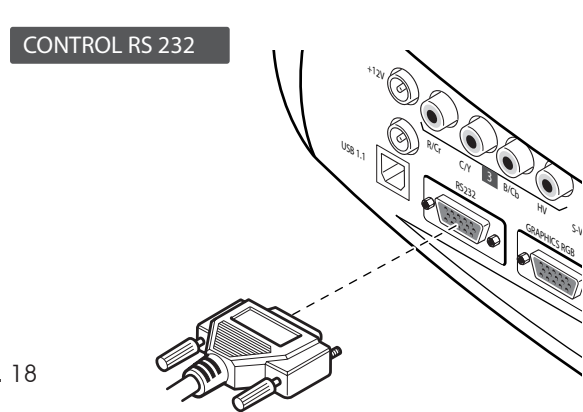
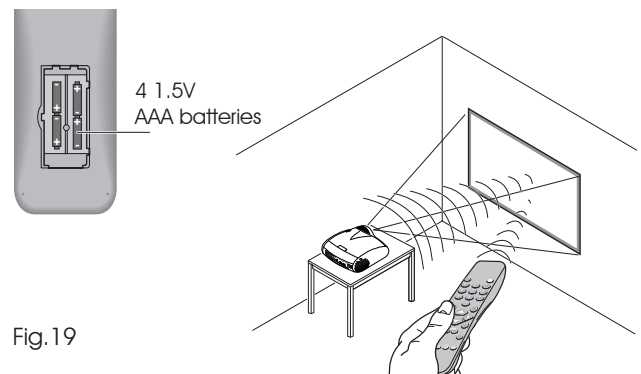

Fig. 19

## 9 ON SCREEN MENU

All system functions can be activated from the keypad or remote control with the aid of a practical and comprehensive system of on screen menus.

### INPUTS

The input selection menu (Inputs) is called by pressing 0 on the remote control and, when no other menu is displayed, using the ▲ and ▼ keys on the keypad. To select an input, scroll the list with the ▲ and ▼ keys until the desired input is highlighted, then press ►.

Display of the input selection menu is terminated by pressing the ESC key, or when the time allowed for displaying the on-screen menu has lapsed (set in the Set-up Menu).

Inputs can receive RGB and YPrPb signals, at 15 kHz, 32 kHz or higher. The association between the input and the type of signal (RGB or YPrPb) is made from the pull-down menu that appears on the right of the < symbol after pressing the ◀ key (Fig. 20).

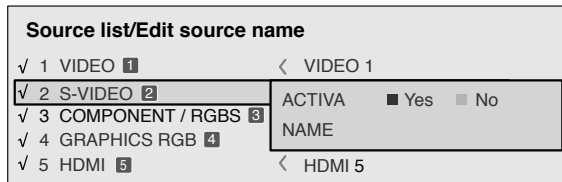

Fig.20

In the pull-down menu it is also possible to choose the horizontal frequency or use the AutoSync feature; in this case the system detect the horizontal frequency signal (15KHz, 32KHz or higher) automatically.

Input is capable of receiving YPrPb or RGB signals coming from DVI-D sources.

The selection should be made from the drop menu following the indications described above.

After selecting the source signal (by means of the ▲ and ▼ keys), press MENU+/MENU- to confirm and close the pull-down menu; the value you have just set will be displayed on the right

of the < symbol.

As with the other inputs, you can now select the input just set by pressing the ► key.

During the short time it takes to find the signal, a box appears showing the signal requested. As soon as the signal is shown in the box additional information is displayed concerning the video standard (for video signals) or resolution (for graphic signals), and format.

From the SETUP menu it is possible to choose to visualize or not this information, for more details check the SOURCE INFORMATION in MENU section.

### MAIN MENU

To access the main menu of the On Screen Display press the MENU key on the keypad or the MENU+ or MENU- key on the remote control.

The main menu is divided into four windows, PICTURE, IMAGE, SETUP and MENU, in which the various adjustments are grouped according to the frequency of use. Use ▲ and ▼ to select the line corresponding to the adjustment you wish to make (Fig. 21).

The various menus only offer the relevant adjustments in accordance with the type of input signal displayed (e.g. certain typical adjustments for video signals, not necessary for graphic signals, do not appear on the menus, and vice versa).

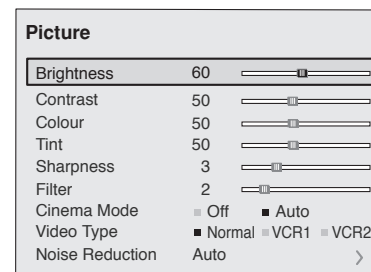

Fig.21

Some adjustments (e.g. BRIGHTNESS and CONTRAST) are associated with a numerical value that can be varied within the set limits using the keys ◀ e ►. For others (e.g. VIDEO TYPE) you can choose among three options presented on the same ◀ e ►).



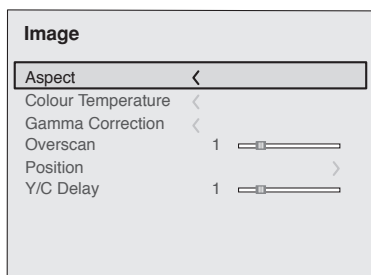

Fig.22

Other adjustments (marked by the < symbol) provide submenus, which appear as a superimposed window in which the selection is made with the ◀ ▶ keys (Fig. 22-22a).

These submenus are accessed by pressing the ◀ key, while exit and return to the upper level occurs by pressing MENU+/. Press ESC on the remote control or keypad to interrupt the menu display or wait for it to disappear automatically after the number of seconds set on the SETUP page.

## PICTURE

This menu features the adjustments related to picture quality. Adjustments that are not available for a given input do not appear on the menu. Table 1 summarises the adjustments available for each input. For a complete overview of the on-screen menus, consult the ON SCREEN MENU LAYOUT in the ADDITIONAL INFORMATION section.

### RIGHTNESS

Use this control to adjust the image's black level without affecting white areas. Increasing the value will give more detail in darker parts of the picture. For correct adjustment it may prove useful to display the signal relative to the grey scale within which the black level and the level immediately above it must be separately identifiable. Alternatively use a scene composed of black objects alongside other dark coloured objects.

### CONTRAST

Use this control to adjust the image's black level without affecting white areas.

To ensure correct adjustment, it may prove useful to display the signal relative to the grey scale, within which the white level and the level immediately below it must be separately identifiable. Alternatively use a scene composed of well-lit white objects surrounded by light coloured objects with lower level lighting.

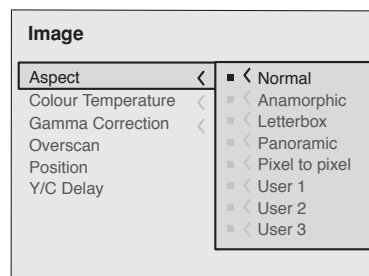

Fig.22a

### COLOR

This control (also called Saturation) increases or decreases the picture colour intensity. When set to zero, colour images will be shown in black and white. Increasing the value, try to find the point at which the colours look natural: suitable references include skin tones and grass in landscape shots.

### TINT

Controls the purity of the colours. Basically determines the red-green ratio of the picture.

Reducing the value will boost the red contents of the picture, increasing the value will boost the green tones. For this adjustment use skin tones or a test pattern image with colour bars as a reference.

### SHARPNESS

Use this adjustment to increase and decrease the level of picture detail.

When the sharpness value is reduced the image details appear less pronounced, while increasing the value raises image definition, making the outline of objects sharper.

Note that an excessively high value may result in a 'noisy' picture and the edges of objects may be unnaturally defined.

### SHARPNESS MODE

This allows you to select the type of processing associated with sharpness adjustment. In the case of a progressive or interlaced video signal VIDEO mode is advisable; with PC graphic signals use GRAPHIC MODE.

### FILTER

This allows you to select the mode in which the input signal is processed. Selecting the most appropriate value for a given input signal ensures the best horizontal and vertical definition and makes the picture sharper.

**CINEMA MODE**

In AUTO the deinterlacer recognises if the video signal source is a movie film (obtained from a Telecine device with 3:2 or 2:2 pull-down) and applies a deinterlace algorithm optimised for this type of signal.

If the video signal source is not identified as a film, or if you select NO the deinterlacer applies a Motion compensated algorithm optimised for video camera signals.

**VIDEO TYPE**

Activates a filter to improve stability of pictures from video recorders or DVD players. To toggle between NORMAL, VCR1 mode and VCR2 mode press  on the remote control.

**NOISE REDUCTION**

This adjustments allows to choose the filter value for noise reduction purposes.

As soon as this option is selected on the menu, the image is divided in two parts.

In the left side the image is not altered by the filter, in the right part the filter is activated.

This allows you to compare the effect of the filter.

It is possible to deactivated the filter (NOT ACTIVE), to use the automatic adjustments (AUTO) or to manually select (MANUAL) the value suitable for the image with the VALUE adjustment.

In case of using the VALUE adjustment, it is enought to select to cursor below and set the value with the ◀ e ▶ keys of the remote control.

Associated to the NOISE REDUCTION there is the possibility to use the specific function (FLESH TONE CORRECTION) to make skin tone more natural. Often the use of noise reduction filter slightly degrades the image in those areas where skin tones are visible. With the use of this function it is possible to maintain an excellent image quality throughout the entire projected image.

**IMAGE**

This menu features adjustments relating to picture position, aspect ratio, etc.

**ASPECT**

This adjustment allows you to change the dimensions and aspect ratio (relationship between width and height) of the displayed image. There are five preset aspects available and three personalised aspects (with user-settable parameters). You can select a different aspect for each source: the selected aspect ratio will be automatically called the next time the

relative source is called.

You can also select the required aspect ratio by repeatedly pressing the ◀▶ key, or by pressing ◀▶ and a numerical key (1...8).

The following aspects are available.

**NORMAL:** projects the image occupying the full height of the screen while maintaining the aspect ratio of the input signal. When the input signal aspect ratio is 4:3 black vertical bands are displayed on the right and left of the picture.

**ANAMORPHIC:** allows a 16:9 picture to be displayed correctly.

**LETTERBOX:** serves to display 4:3 letterbox image (with source signal having black bands above and below the picture) so that it fills the 16:9 screen and maintains the correct aspect ratio.

**PANORAMIC:** this aspect stretches the 4:3 image, slightly cropping the upper and lower parts.

Panoramic is ideal for displaying a 4:3 image on the 16:9 screen of the Display.

**PIXEL TO PIXEL:** this aspect displays the image as it is input without adapting it to the screen.

The image is projected in the centre of the screen and if its horizontal and/or vertical dimensions are smaller than the display,

Table 1

Adjustments	Inputs					
	Video S-Video	RGBS 15kHz Y/Cb 15kHz	RGBS	YCrCb	RGB Grafico	HDMI™
Brightness	●	●	●	●	●	●
Contrast	●	●	●	●	●	●
Colour	●	●	-	●	-	-
Tint	○	●	-	●	-	-
Sharpness	●	●	●	●	●	●
Sharpness Mode	-	-	●	●	●	●
Filter	●	●	-	-	-	-
Cinema Mode	●	●	-	-	-	-
Video Type	●	●	-	-	-	-
Noise reduction	●	●	-	-	-	-
Flesh tone correction	●	●	-	-	-	-

○ Present only if the Video Standard is NTSC

it is bounded by vertical and/or horizontal black bands.

**USER 1, 2, 3:** When none of the preset formulas are suitable, the User formulas are available, with the facility for continuous horizontal and vertical adjustment of picture size.

#### SCREEN CONTROL

If an appropriate screen-masking interface is connected to the 12V output socket it is possible, for each aspect chosen, to re-frame the screen to a variety of aspect ratios and screen sizes (please refer to the screen manufacturer's manual).

#### COLOR TEMPERATURE

The color temperature adjustment is made by positioning the white point inside CIE chromaticity diagram. The systems allows to choose from 36 predefined white points inside the neutral color area (Fig.23).

The correlated color temperature varies along horizontal lines, low temperatures are present in the right side (where the red component is increased), in the left side of the diagram you can find high temperature values ( in which blue component is higher). The points along the lower horizontal line (Fig.24) represent colors that belong to the black body curve.

Along vertical lines the color temperature is constant but is different from black body curve, which mean if you select point from the high part of the diagram you increase the green componet, while low part of diagram cause an increase of purple component.

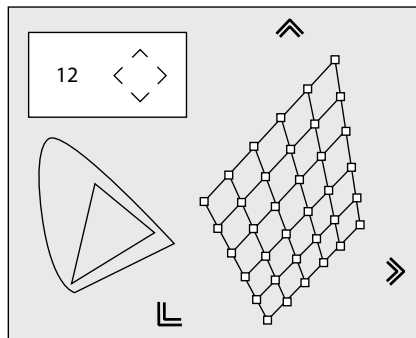

Fig. 23

#### GAMMA CORRECTION

Determines the system's response to the grey scale, emphasizing or attenuating the different grades of brightness (blacks,

dark, medium, light grey, whites) in the projected image. The projector is equipped with several gamma functions, allowing the best display of any image in relation to the video source type, ambient light conditions, and the personal preferences of the viewer.

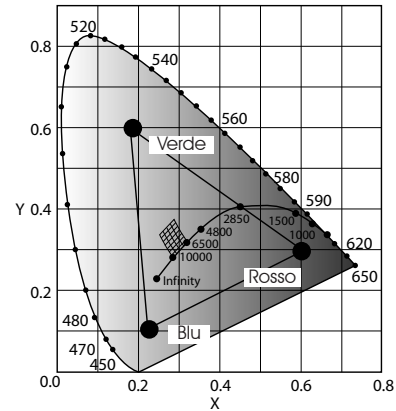

Fig. 24

The system provides 4 groups of gamma curves: Standard (ST), Enhanced SIM2 (EN), Graphics (GR), and Personal. The Standard curve is suitable for generic use: this curve is well adapted to displaying images from video cameras, digital cameras, and films or photos from personal computers. The Enhanced group is suitable for viewing movie films. The Graphics group is suitable for displaying simple graphic images (desktop PC, CAD, PC presentations,...). The Personal setting allows the gamma curve to be defined parametrically. The user can select the coefficient that determines the shape of the curve. Coefficient values between 1.5 and 2.2 serve to emphasise details in darker parts of the picture although the global perception of contrast is reduced. Values higher than 2.2 increase the global perception of contrast while attenuating the visibility of details in darker areas of the picture. With the most common video sources a parameter value of 2.2 will give high quality pictures with the right amount of contrast.

#### POSITION

Use this adjustment to position the image vertically and horizontally. Determines the aspect ratio of the projected image.

These parameters do not normally require adjustment because the system checks the input signal and automatically sets the most suitable values.

However, if the image is not perfectly centralised it may prove useful to request the system to repeat the input signal analysis

and image positioning, calling the automatic control procedure from the AUTO button on the remote control or keypad. When this procedure is called it is helpful to have a white or light coloured background on the screen in the current picture.

### FREQUENCY/PHASE

These adjustments, available for progressive signals and for signals from PC, ensure correspondence between the number of pixels making up the signal and the number of pixels making up the projected image. These parameters do not normally require adjustment because the system checks the input signal and automatically sets the most suitable values.

However, if the image appears disturbed (loss of position within the equidistant vertical bands or instability and lack of sharpness on the narrow vertical lines) it may help to prompt the system to repeat the input signal analysis and determination of the best parameters by calling the automatic adjustment procedure with the AUTO key on the remote control or on the keypad.

If the automatic procedure fails to have the required effect, enter the frequency and phase values manually and approach the screen sufficiently to observe the effects of the adjustments.

### Y / C DELAY

In the case of Video and S-Video signals, it may be necessary to correct horizontal colour misalignment within the projected image. For a given video standard (e.g. PAL or NTSC) the stored value does not normally require further fine-tuning, unless the source or connection cable has changed.

**Table 2**

Adjustments	Inputs					
	Video S-Video	RGBS 15kHz YCrCb 15kHz	RGBS	YCrCb	RGB Grafico	HDMI™
Position	•	•	•	•	•	-
Aspect	•	•	•	•	•	•
Frequency	-	-	•	•	•	-
Phase	-	-	•	•	•	-
Colour Temperature	•	•	•	•	•	•
Gamma Correction	•	•	•	•	•	•
Overscan	•	•	•	•	•	•
Y/C Delay	•	•	-	-	-	-

**Table 3 - Gamma Correction**

<b>Standard Gamma function</b>	ST1	For generic uses.	
	<b>Enhanced SIM2 Gamma function</b>	EN1	Suitable for displaying images from sources such as video cameras, digital cameras or TV studios in high ambient light conditions.
		EN2	Suitable for displaying images from sources such as video cameras, digital cameras or TV studios in low ambient light conditions.
		EN3	Suitable for displaying movie films in high ambient light conditions.
		EN4	Suitable for displaying movie films in medium ambient light conditions.
EN5		Suitable for displaying movie films in controlled ambient light conditions.	
<b>Graphics Gamma function</b>	G1	Suitable for displaying graphic images (e.g. Windows Desktop) in medium ambient light conditions.	
	G2	Suitable for displaying graphic images in controlled ambient light conditions.	

## SETUP

The setup menu contains less frequently used adjustments that may be required during installation (e.g. On Screen Display language selection or the display of Test Patterns).

### ORIENTATION

Select the option that best describes the installation i.e. desktop front, ceiling front, desktop rear and ceiling rear (Fig. 25).

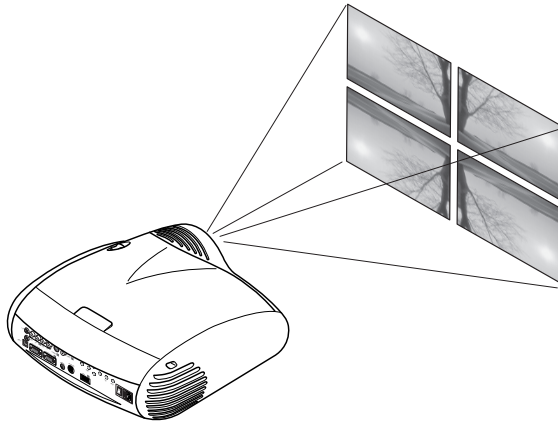

Fig.25

### HORIZONTAL/VERTICAL KEYSTONE

To obtain maximum quality of the projected image, we recommend the installation of the projector on a level platform parallel and central to the screen.

Adjust the feet underneath to obtain a level position, lining up the base of the projected image to the base of the projection screen (Fig. 26).

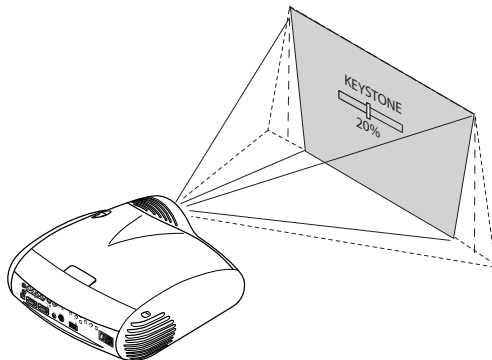

Fig.26

If the event you are unable to centre the image within the screen area, tilt the projector until the image is correctly positioned. Any keystone error can be removed by the Keystone adjustment in the Set up menu. The keystone adjustment helps to compensate possible horizontal tilts of the projector.

### LENS

The ZOOM adjustment impacts on the motorized zoom lens allowing to increase or decrease the dimension of the projected image.

The FOCUS adjustment impacts on the motorized lens focus, allowing to obtain the highest definition on the projected image, an accurate focus setting should allow the viewer to distinguish each pixel that create the image one from another.

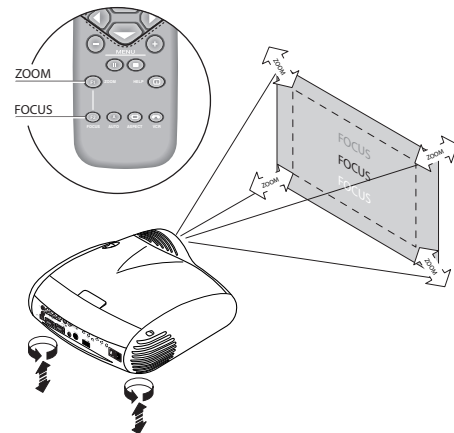

Fig. 27

In the initial phase of installation the configurable keys (F1, F2) serve as optical zoom and optical focus (Fig. 28).

### LAMP POWER

If your room is especially dark, the images from the system C3X could result excessively bright. In order to enjoy wonderful images, the ECOMODE function activation allows to reduce the power used to feed the lamp. In this way, the brightness of the image will be adapted to your projection conditions and a grater life lamp will be guaranteed.

### POWER ON

If active (AUTO) allows to power up the system directly from the power feeder, once the initializing phase is completed.

If not active (STAND-BY) once the initializing phase is completed the system remains in a stand-by mode waiting to receive the

power on command from the remote control or the key pad.

### TEST PATTERNS

Displays a series of five test patterns, useful for the installation of the projector.

Press ◀ and ▶ keys to browse pattern.

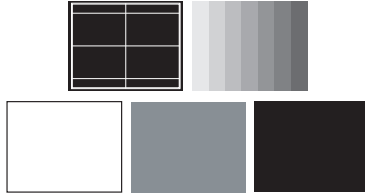

Fig. 28

### FACTORY DEFAULTS

Reconfigures the projector to original factory settings except Position, Orientation, Y/C Delay, Zoom and Focus (Fig. 29).

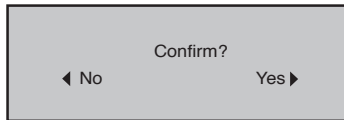

Fig. 29

## ON SCREEN MENU

### LANGUAGE

Lists the languages available for the On Screen Display menus.

### SOURCE LIST

In order for the C3X system to be more flexible, the following described functions allow to modify the input selection menu making it more user friendly.

The main window shows all the inputs available on the Projector. If one or more inputs are not utilized, it is often helpful to blank them from the input list (accessed with the 0 key).

Once the input has been chosen, in the drop menu that appears by pressing the ◀ key, it is possible to activate the source (Fig. 30).

The exclusion or activation of the source will automatically renumber the remaining active inputs.

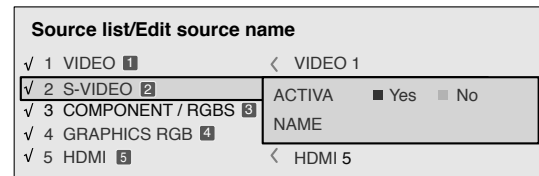

Fig. 30

The inputs with an active video signal (visible in the input selection menu) are marked with a check symbol.

It can be also helpful to identify the input with a name chosen by the user (for example with the name of the connected source) rather than with the signal type.

Once chosen to have the input visible, in the drop menu, by selecting the Name option it is possible to rename the source in use.

This will make it easier to remember the source connected to a specific input. You can use up to 12 alphanumeric letters to name the source (for more details check the "Insert text" section).

### INSERT TEXT

You will be able to insert text easily and rapidly by accessing the text insertion menu (fig. 31).

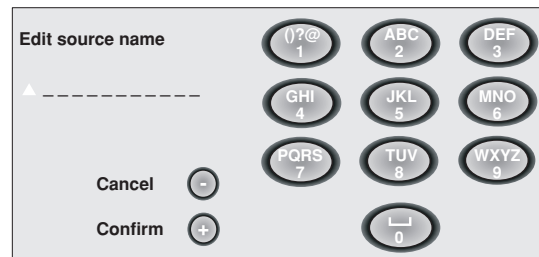

Fig.31

The text insertion mode remains the same if text is being inserted for the first time or if a previously inserted name is being edited. The letter insertion can be done in any available position (represented by horizontal lines). Use the ◀ and ▶ keys to move between letters either left or right respectively.

Press the numeric key matching the letter (Fig. 32), the first click of the key selects the first letter, the second click the second letter and so on.

The available letters are shown in the text insertion menu. Once one letter has been inserted, to insert the following one it is necessary to move with the cursor in the next right position with the ► key of the remote control, repeat this procedure to insert other letters.

Use the ▲ key to switch from small case to capital letters and viceversa.

Any mistake can be deleted with the ▼ key once it has been positioned on the wrong letter.

Once the text insertion process is finished, it can be confirmed and saved by clicking the MENU+ key.

If you want to delete the modifications use the MENU- key of the remote control.

### F1/F2 KEYS

This allows to assign different functions to the remote control keys, named F1 and F2.

The window is made of 6 options, once for each line and by two columns showing the F1-F2 keys. The choice between F1 and F2 is made by the ◀ and ▶ keys of the remote control; the function given to F1 and F2 is chosen with the ▼ and ▲ keys. The function delivered by the key is memorized by the intersection on the line and column.

In the following window are described the 6 options

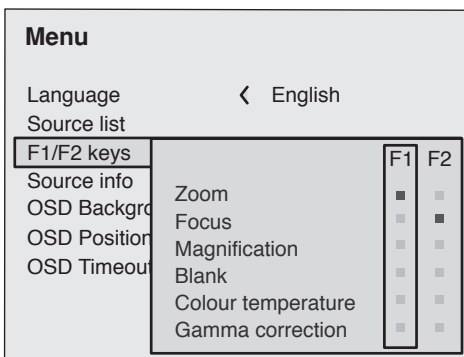

Fig.32

### Zoom

Allows to access the optic zoom, where the ◀ and ▶ keys allow to increase or decrease the size of the projected image.

### Focus

Once selected, the ◀ and ▶ keys allow to focus the image.

### Magnification

Allows you to select the area to be viewed and then magnify the projected image. The degree of enlargement is selected in Zoom mode (identified by a magnifying glass in the centre of the image) using the ◀ and ▶ keys. The area of the picture to be enlarged is selected in Pan mode (symbol in the centre of the picture) using the ◀, ▶, ▼ and ▲ arrow keys. You can toggle between Zoom and Pan mode by pressing the F1/F2 key on the remote control.

### Blank

Blanks the active video signal producing a completely black screen. Once pressed the key an indication of a few seconds on the OSD will confirm its activation. A click of any other key of the remote control allows to restore the previous settings.

### Color temperature

The following click of the key (F1 or F2) allows to choose between the different color temperatures available.

### Gamma correction

The following click of the key (F1 or F2) allows to choose between the different gamma curves available.

### SOURCE INFORMATION

When active (YES) each source change will show the information related to the signal. If not active (NO) there will be no information on the selected source..

### OSD BACKGROUND

Determines the type of background for the On Screen Display.

### OSD TIMEOUT

Use this adjustment to set the display time after which the On Screen Display will disappear.

### OSD POSITION

Allows the On Screen Display to be positioned in a particular area of the projected image. The OSD can be positioned using the arrow keys for fine adjustments or keys 1...9 on the remote control to select one of 9 preset positions.



## MEMORIES

The main parameters of the image may be saved in distinct groups of values (known as 'Memories'); these parameters can subsequently be applied all together by way of a single command.

There are 3 distinct Memories (Memory 1, Memory 2, Memory 3) for each of the 25 signal types managed: making a total of 75 different available Memories. The image parameters that can be saved/recalled by the Memories management system are the following:

### Image



BRIGHTNESS  
CONTRAST  
COLOR  
TINT  
SHARPNESS  
FILTER  
SHARPNESS MODE  
VIDEO TYPE  
NOISE REDUCTION

### Picture

ASPECT  
COLOR TEMP.  
OVERSCAN  
GAMMA

### Setup

LAMP POWER

Some of these parameters may not be available for certain inputs or certain input signals, as indicated in Tables 4 and 5. The menu page for the Memories management functions is activated by pressing the  key on the remote control or the  key on the keypad (Fig. 33).

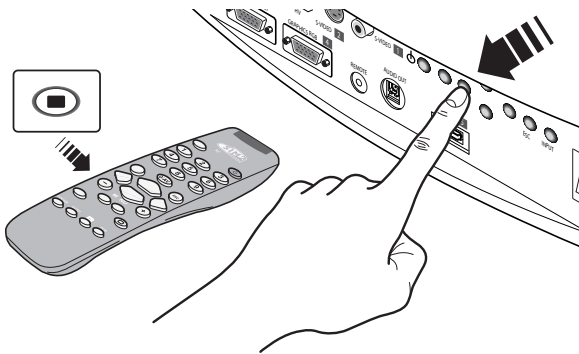



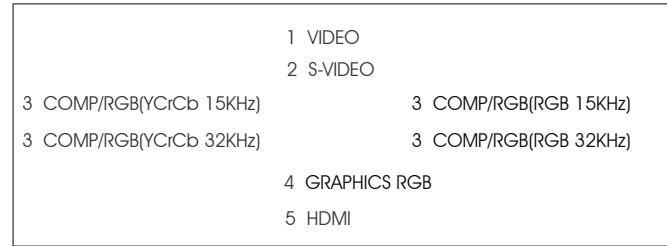

Fig.33

The operations that can be performed on each memory selected are described here below.

### Save a memory

To save the current values of the image parameters in Memory 1, use the  and  keys to move to line '1' and then open the pull-down menu by pressing the  key (Fig. 34). Then select the option 'Save current settings'. To confirm that the operation



has been completed successfully, the message Current settings saved in Memory 1 is displayed at the bottom of the screen and the letter 'S' appears to the left of the memory name. The same procedure is used to save parameters in Memories 2 and 3.

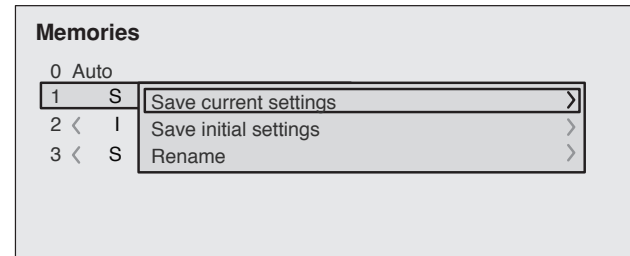



Fig.34

### Recall a memory

To recall a Memory, select the desired line and press . The parameters saved in the selected Memory will be applied to the image displayed and a message will appear to confirm the operation Memory 1 recalled. The Memory recalled will be associated with the source and signal type, and will be automatically recalled every time that particular source and signal type combination is selected.

### Save default settings

To restore the original values to a previously modified Memory, select the line corresponding to the Memory in question and open the pull-down menu ( key). Then select the line Initial settings saved in Memory 1. To confirm that the operation has

been completed successfully, the message Memory 1 initialised is displayed at the bottom of the screen and the letter 'I' appears to the left of the name of the memory.

### **Rename a memory**

It is possible to assign a name to each Memory. To assign a name (with a maximum length of 12 alphanumeric characters) to a Memory, select the option 'Rename' from the corresponding pull-down menu. Enter the text following the procedure indicated in paragraph SOURCE LIST.

### **Restore Current Settings**

On entering the MEMORIES menu, a copy of the current settings is saved in a temporary menu (labelled with 0 - AUTO). Once one or more memories have been recalled, you can restore the settings that were effective at the moment the Memories menu was accessed by selecting 0 - AUTO. However, this operation must be completed before the MEMORIES menu page disappears (30 seconds after the last operation commanded from the remote control or the keypad). The next time it appears, the temporary memory will contain new information that takes into account any Memories selected the penultimate time the 'Memories' page was accessed.

Memory 0 (- AUTO) can be used even when you do not wish to enable the Memories management function for the signal currently in use. Once Memory 0 has been selected, when a source is chosen, the settings that were effective at the time the Memory was previously recalled will be automatically applied.

### **INFO**

---

Displays the current status of the projector and information concerning the projected video/graphic signal.

This function is displayed on pressing **I** on the remote control (or, in the absence of the On Screen Display, the ► key on the remote control).

### **QUICK MENUS**

---

The quick menus provide access to the main adjustments that affect image quality, without calling the main On Screen menus.

BRIGHTNESS, CONTRAST, COLOUR, TINT, SHARPNESS and FILTER adjustments appear at the bottom of the screen one after the other when the ▼ and ▲ keys are pressed .

### **MESSAGES**

---

The following messages may appear during operation of the system:

#### **No signal**

---

The system does not recognise any signal applied to the selected input. In this case:

- Make sure the selected input is connected to a video or graphic signal and that that source is functioning correctly.
- Check the condition of the cables used to connect the system to the various sources.
- Make sure the video or graphic signals supplied by the source are compatible with the system's technical specifications and, in particular, with those of the selected input.

#### **Out of range**

---

This message appears when either the resolution or the vertical/horizontal frequency of the input signal exceeds C3X specifications (e.g. a QXGA graphic signal) or when an input is supplied with an incompatible signal (e.g. after setting the components input to YPrPb 15kHz a progressive signal is connected).

#### **Substitution lamp**

---

If the lamp hours exceed the 90% of the life lamp, at every switching on , a brief message appears on the screen to remember the need of replacing it in a short time.

If the lamp life is greater than 100% the message above persists until the ESC key is pressed.

---

## 10 CLEANING AND MAINTENANCE

---

The Projector do not require internal cleaning. There is no user serviceable parts inside the projector. Please refer all service requirements to qualified personnel.

### **Cleaning the projector's cover:**

Use a soft slightly damp cloth. Do not use abrasive cleaners, solvents or other harsh chemicals, as this will damage the finish of the cover. Avoid direct cleaning of the rear panel's screen-printing.

### **Cleaning the lens:**

The lens may be cleaned with a very soft, non-abrasive small brush, in order to remove dust particles. Alternatively, use a soft dry cleaning cloth (of the type used for camera lens cleaning) to remove fingerprints and grease marks.

---

## 11 TROUBLESHOOTING GUIDE

---

### **No power (Green and red LED are OFF)**

---

- Check the power switch at the rear: it must be in position I.
- Check if the power cable has been connected correctly to a working socket.
- Check the power socket fuse, at the rear of the projector.
- Replace the fuse on the mains socket with an identical type (T 5A H) (Fig. 2).
- Should the problem persist, seek authorised technical assistance.

### **The lamp is not coming on**

---

- Allow a few minutes pause between switching off and turning on again (from stand-by). This will allow the lamp to cool down sufficiently.
- If the lamp doesn't come on – even though the projector has had sufficient time to cool down – seek technical assistance from your nearest Dealer.

### **No image**

---

- Check that the selected input is actually connected to a active video or graphic signal.
- Check that the above source actually works.
- Verify compatibility of video/graphic signals with the technical specifications of the projector.
- Check the integrity of cables used to connect various sources.

- Check the cooling air inlets or air outlets on the units are not obstructed and the room temperature is below 35°C (95°F).

### **Image is disturbed, unstable or noisy**

---

- Verify compatibility of video/graphic signals with the technical specifications of the projector.
- Check the integrity of cables connecting projector to various sources.
- If the signal source is a terrestrial broadcast (via a VCR) check that the receiving channel has been correctly tuned in and that the aerial system is in good working order.
- Should the problem be present with a signal coming from a video-recorder, ensure that the videotape is an Original "first generation" copy and in good condition.
- Adjust the VCR's tracking control for optimum picture performance. Ensure the VCR mode is active in the Picture menu.

### **Incomplete image along borders (vertical and horizontal)**

---

- Compare compatibility of video/graphic signals and technical specifications of your projector.
- Press A on your remote control or AUTO on keypad to execute automatic adjustments.

- Adjust the horizontal and vertical position of projected image by selecting POSITION on the IMAGE ADJUSTMENTS menu.
- Adjust the width and height of image, selecting ASPECT in the IMAGE ADJUSTMENTS menu.
- Adjust the Overscan value in the IMAGE/OVERSCAN menu.

#### **Image too dark, too pale or unnaturally coloured**

---

- Verify compatibility of video/graphic signals with technical specifications of your projector.
- Go to PICTURE menu, select and regulate any of the following, accordingly: CONTRAST, BRIGHTNESS, COLOR, and TINT.
- If necessary, reset the COLOR TEMPERATURE and GAMMA CORRECTION (found on the IMAGE ADJUSTMENTS / ADVANCED SETTINGS menu).

#### **Graphic image with poor quality vertical detail**

---

- Verify compatibility of video/graphic signals with technical specifications of your projector.
- Press A on your remote control or AUTO on keypad to execute automatic adjustments.
- Adjust FREQUENCY and PHASE parameters, found in the IMAGE ADJUSTMENTS menu, to optimise vertical detail of the projected image.

#### **Video Image showing colour misalignment on vertical details**

---

- Verify compatibility of video/graphic signals with technical specifications of your projector.
- Adjust Y/C DELAY settings in the IMAGE ADJUSTMENTS / ADVANCED SETTINGS to reduce colour misalignment. For best results use an external colour bar test pattern source.

#### **Remote control does not work**

---

- Check the batteries and for correct polarity.
- Ensure that the area between the infrared sensor (front of projector) and the remote control is free of obstruction.
- Ensure that infrared sensors (front and rear of projector) are not exposed to intense light levels.

---

## **12 OPTIONAL ACCESSORIES**

---

You can purchase the following optional accessories at your Dealer:

- Ceiling Bracket Kit.
- Type of lens

Up to six types of lenses are available to accommodate different throw distances and your specific installations. See ADDITIONAL INFORMATION for more details on throw distances and the dimensions of the image projected. To change the lens, contact always your nearest dealer.

Use only original, or SIM2 Multimedia approved, accessories.

**CAUTION: for ceiling installation, by means of suspension bracket, carefully follow the instructions and safety instructions recommended by the Manufacturer in the bracket's literature.**

Rivolgetevi sempre al vostro centro di assistenza per sostituire l'obiettivo. Utilizzate solo accessori originali o approvati da **SIM2 Multimedia**.

**A TECHNICAL SPECIFICATIONS****ELECTRICAL**

Input signals:

- 1 COMPOSITE VIDEO (CVBS)
  - RCA type connectors, gold-plated
  - 1,0 V<sub>pp</sub> / 75 Ω, negative synchronisation
- 1 S-VIDEO (Y/C)
  - 4-pin mini-DIN connectors
  - Y: 1,0 V<sub>pp</sub> / 75 Ω, negative synchronisation
  - C: 0,286 V<sub>pp</sub> / 75 Ω, [NTSC nominal burst level]
  - 0,3 V<sub>pp</sub> / 75 Ω [PAL, SECAM nominal burst level]
- 1 COMPONENTI (Y/Pb/H/V) - RGBS
  - 1 set of 4 RCA connectors
  - Components signal
    - Y: 1,0 V<sub>pp</sub> / 75 Ω, negative or 3-level synchronisation
    - Pr,Pb:0,7 V<sub>pp</sub> / 75 Ω
  - RGB signal
    - R,B:0,7 V<sub>pp</sub> / 75 Ω
    - G: 0,7 V<sub>pp</sub> / 75 Ω, HV Sync
  - 1,0 V<sub>pp</sub> / 75 Ω, negative or 3-level synchronisation
  - TTL positive or negative, 0,3-5 V<sub>pp</sub> / 1 kΩ
- 1 RGBHV (analogue RGB)
  - female DB15HD connectors
  - R,B: 0,7 V<sub>pp</sub> / 75 Ω
  - G:0,7 V<sub>pp</sub> / 75 Ω, separate H/V Sync or H+V Sync
  - 1,0 V<sub>pp</sub> / 75 Ω, negative or 3-level synchronisation
  - TTL positive or negative, 0,3-5 V<sub>pp</sub> / 1 kΩ
- 1 HDMI™

Control:	Remote control, via RS232 from PC or home automation devices, USB 1.1
Horizontal frequency:	from 15 to 80 kHz (up to UXGA, 85 Hz)
Vertical frequency:	48 -100 Hz
Video standards:	automatically selected (PAL B, G, H, I, M, N, 60, SECAM, NTSC 3.58 and 4.43)
High definition video:	ATSC HDTV (480p, 720p, 1080i,)
Graphic standards:	VGA, SVGA, XGA, SXGA, UXGA
Deinterlacer:	Faroudja chipset, DCDi™, 3:2 pull-down sequence conversion
Colour temperature:	from 6500 to 10000 K
Outputs:	- 2 12-V jack connector outputs (1 active with system powered on, 1 active with 16:9 aspect ratio selected) - 1 Optical S/PDIF audio output Toslink connector

**GENERAL PROJECTOR**

Power supply cable:	(EU, UK e US); lenght 2m
Supply:	da 100 a 240 Vac, tolerance +/- 10% frequency from 48 to 62 Hz
Consumption:	350 W max (240 W Max C3X LITE)
Fuse:	T 5 A H, 5 x 20 mm
Dimensions of projector:	435x190x430 mm (LxAxP)
Weight of projector:	11 kg
Operation temperature:	10 to 35°C
Transportation temp.:	-15 to 55°C
Storage temperature:	-15 to 55°C
Humidity:	20% a 95% humidity non-condensing
Safety:	EN 60950
Transportability:	desktop equipment
Compatibility:	EN 55022 Class B EN 55024 EN 61000-3-2 EN 61000-3-3
Transportation:	IEC 68-2-31, IEC 68-2-32

## Picture

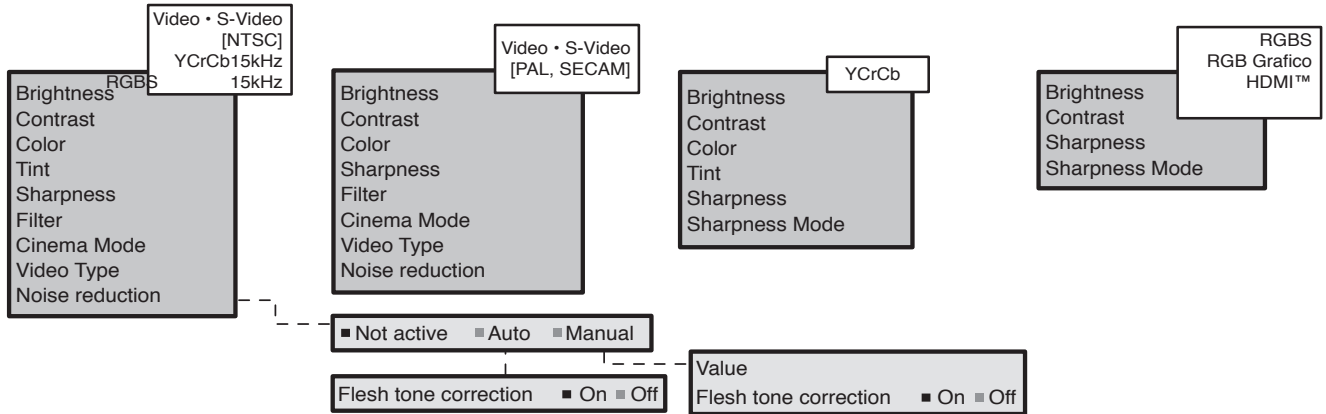

## Image

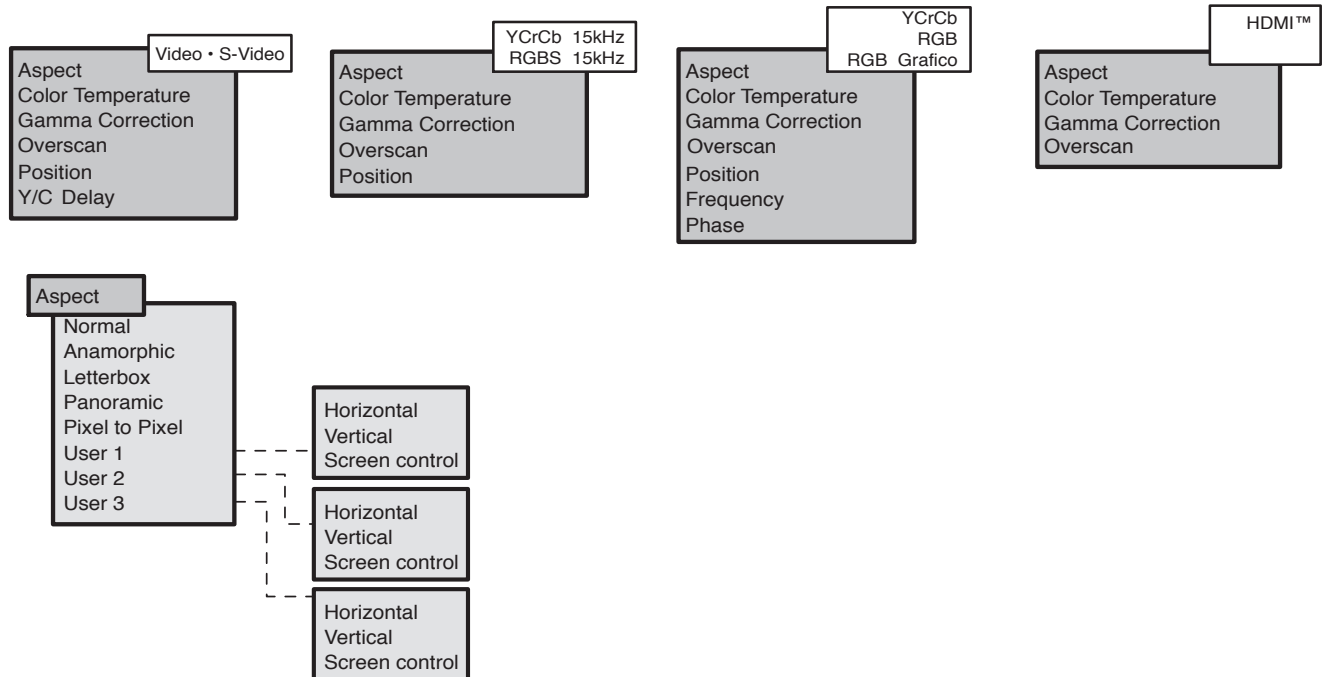

## Setup

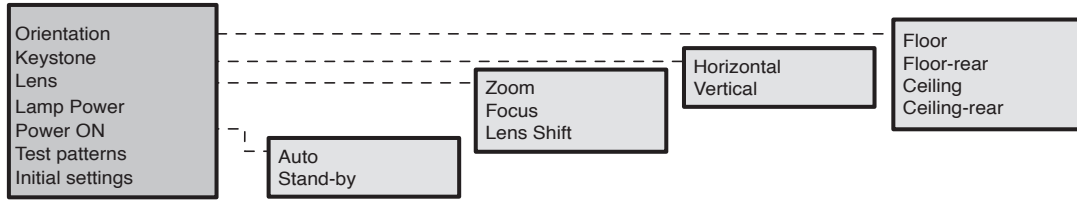

## Menu

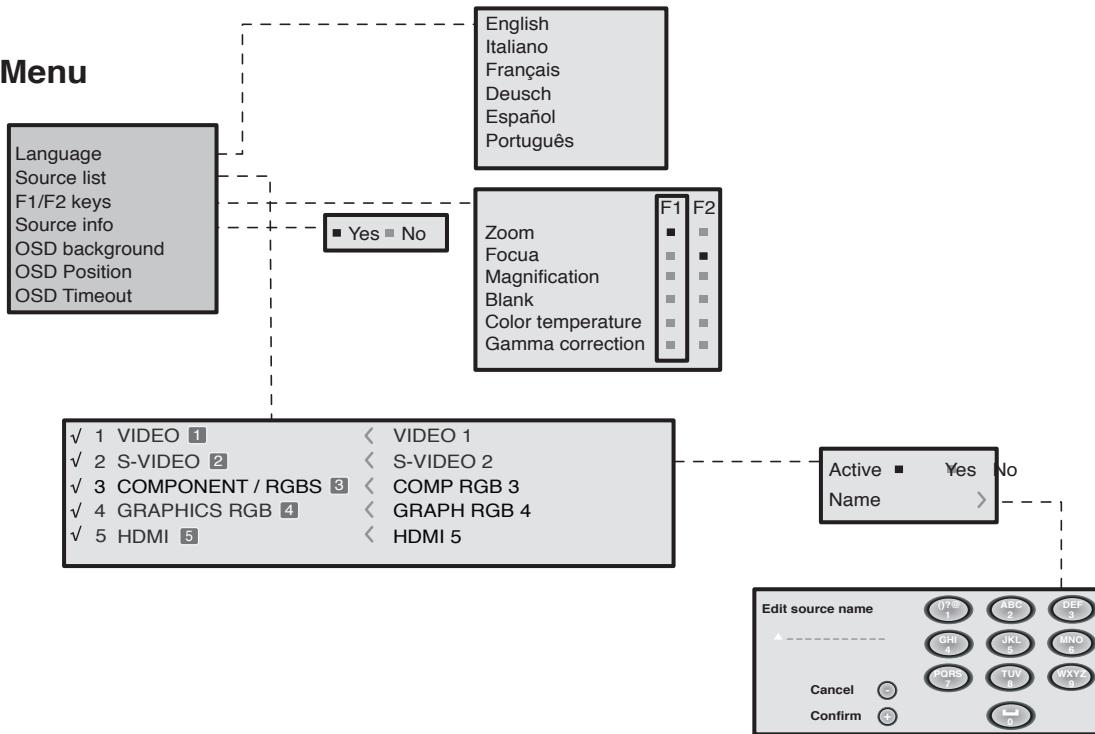

## Memories

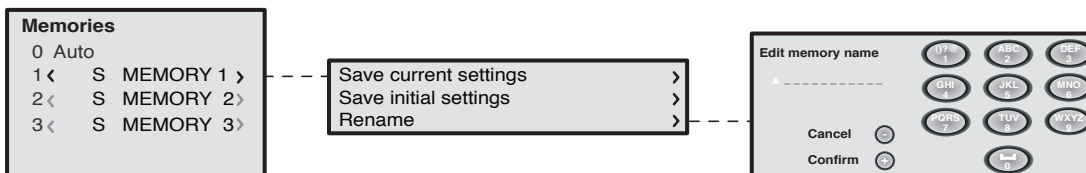



**C DIMENSIONS**

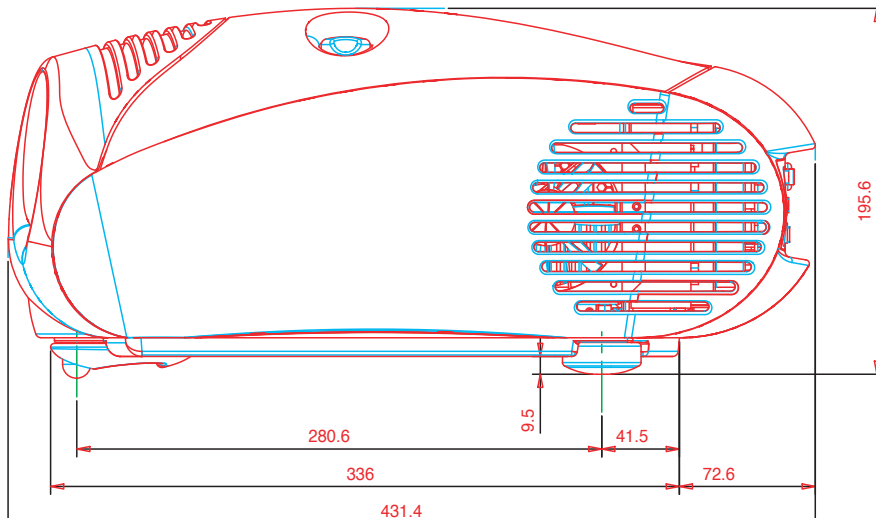
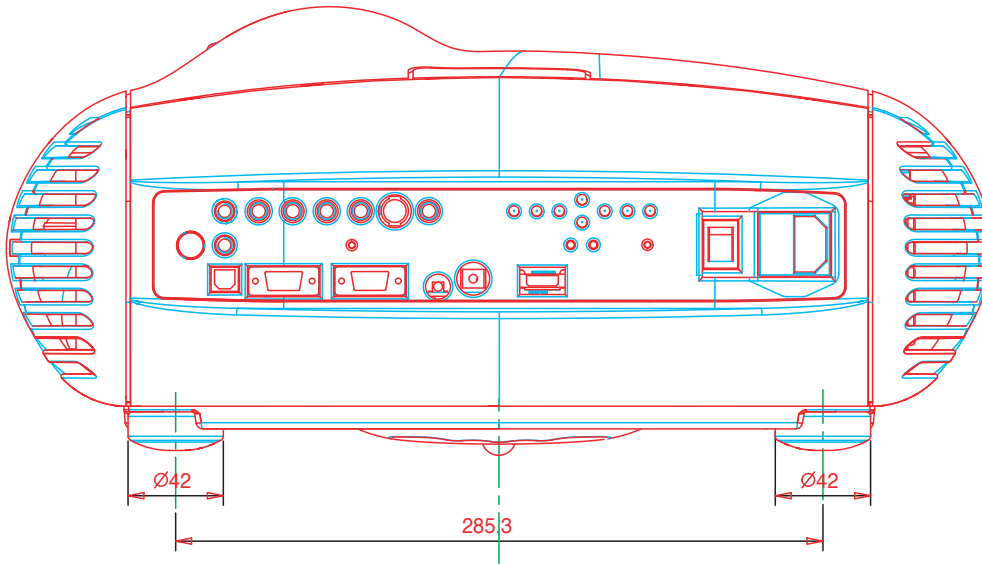



SIM2 Multimedia S.p.a. • Viale Lino Zanussi, 11 • 33170 Pordenone - ITALY  
Phone +39.434.383.253-256 • Fax +39.434.383260-261  
www.sim2.com • e-mail: info@sim2.it

SIM2 USA Inc. • 10108 USA Today Way • 33025 Miramar FL - USA  
Phone +1.954.4422999 • Fax +1.954.4422998  
www.sim2usa.com • e-mail: sales@sim2usa.com

SIM2 Deutschland GmbH • Gewerbepark, 17 D-35606 Solms  
Phone 0800.800.7462 • Fax 0800.900.7462  
www.sim2.com • e-mail: info.de@sim2.it

SIM2 UK LTD • Steinway House Worth Farm,  
Little Horsted Nr. Uckfield, East Sussex TN22 5TT  
Phone +44.01825.750850 • Fax +44.01825.750851  
www.sim2.co.uk • e-mail: kate.buckle@sim2.co.uk

SIM2 Multimedia is certified



---

• Due to the constant product development, specifications and design might be subject to change without notice.